

A ~~Sunshine~~

Glass & Aluminum

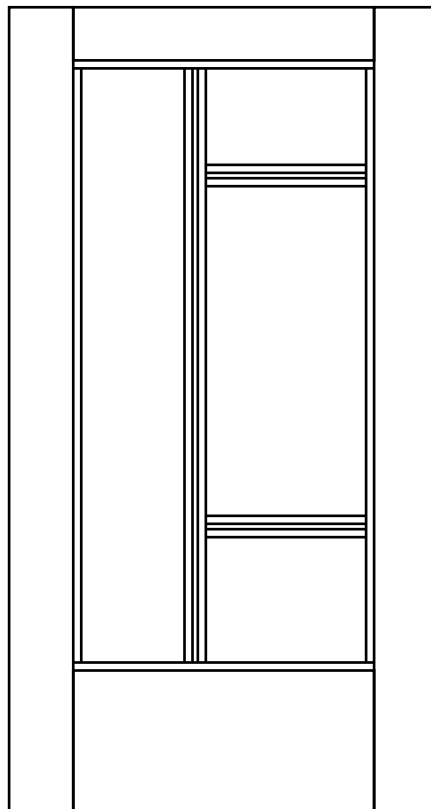

19TH EDITION 6/30/19

Tel. 718-932-8080

Fax. 718-932-6028

I n d e x

Stainless Steel Fabrication	002
Glass, Tempered Lite	003
Mirror	004
Lami	004
Plastic	004
Fin Tubings System	005
Fascia	005
Angles	006
Saddles	006
Stucco Panel	007
Aluminum Sheets	007
Stainless Sheets	008
Brass Sheets	008
U-Channel	008
1/4" Pocket Tube System	010
1" Pocket Tube System	011
Curtain(Pressure) Wall System	012
Aluminum Door Specs	013
Stock Doors	014
Stock Frames	015
Stock Frame W/ Transom	016
Aluminum Door Assembly Detail	017
Aluminum Door Stock Length	018
Aluminum Door Hardwares	020
Herculite Door Assembly Detail	023
Herculite Door Stock Length	024
Herculite Door Hardware	025
Handles	027
Patch Style Door Hardware	029
Glazing Hardwares	031
Showcase Accessories	035
Shower Door Hardware	036
Mirror Moldings	036

Stainless Steel Fabrication

V-Shape Groove Cut Stainless Steel Bending

Sunshine's V-Groove Bending

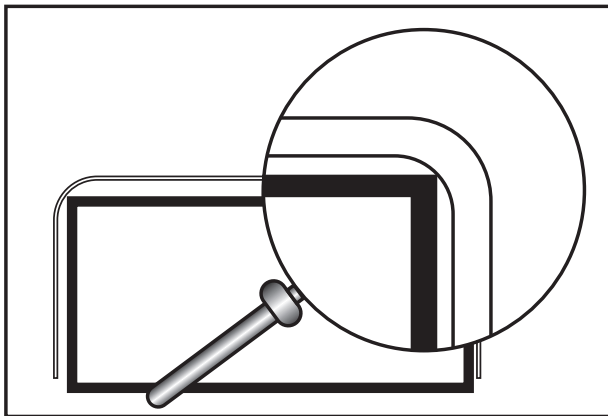

Fig.1

Conventional Bending

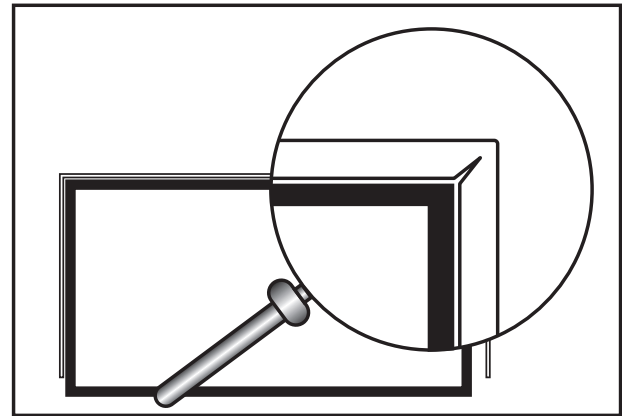

Fig. 2

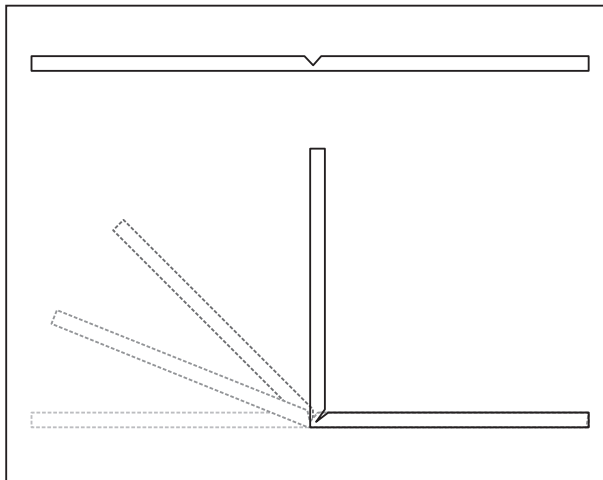

Fig. 3

A Sunshine Stainless & Fabrication presents **V-Shape groove cutting** in stainless steel bending (Fig.3). We use V-shape groove cut technology to minimize the radius in stainless sheet bending. Conventional bending forms large radius (fig.2) at corner, but with V-shape groove technic, there are very small radius (fig.1) form at the corner. We could make (Bend) any shape, size and any quantity, which is very useful for store front cladding.











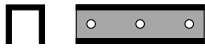





003**GLASS ♦ TEMPERED LITES**

<u>DESCRIPTION</u>	<u>No.</u>	<u>SIZES</u>				
<u>1/16" CLEAR GLASS</u>	1011	36x84	48x84			
<u>1/8" CLEAR GLASS</u>	1021	36x84	48x84			
<u>1/8" BRONZE GLASS</u>	1022	60x84				
<u>1/8" GREY GLASS</u>	1023	60x84				
<u>3/16" CLEAR GLASS</u>	1031	84x130				
<u>1/4" CLEAR GLASS</u>	1041	48x105	60x105	72x105	84x130	96x130
<u>1/4" BRONZE GLASS</u>	1042	96x130				
<u>1/4" GRAY GLASS</u>	1043	96x130				
<u>1/4" SUPER GY GLASS</u>	1046	96x130				
<u>1/4" OPTI WHITE GLASS</u>	1044	84x130				
<u>3/8" CLEAR GLASS</u>	1051	72x130	84x130	96x130		
<u>3/8" BRONZE GLASS</u>	1052	96x130				
<u>3/8" GRAY GLASS</u>	1053	96x130				
<u>3/8" OPTI WHITE GLASS</u>	1054	96x130				
<u>1/2" CLEAR GLASS</u>	1061	72x130	84x130	96x130		
<u>1/2" BRONZE GLASS</u>	1062	96x130				
<u>1/2" OPTI WHITE GLASS</u>	1064	96x130				
<u>3/16" AQUATEX</u>	1131	72x96				
<u>5/32" REED</u>	1135	72x84				
<u>3/16" RAIN</u>	1138	72x96				
<u>1/8" PAT 62</u>	1126	60x84				
<u>3/16" PAT 62</u>	1136	72x96				
<u>1/4" ACID WASH GLASS</u>	1139	88.1/2x126				
<u>3/8" ACID WASH GLASS</u>	1159	88.1/2x126				
<u>1/2" ACID WASH GLASS</u>	1169	88.1/2x126				
<u>1/4" ROUGH WIRED</u>	1120	72x96				
<u>1/4" POL WIRE SQU</u>	1300	78x100	78x130			
<u>1/4" POL WIRE DIA</u>	1301	48x100	78x100	78x130		
<u>3/16" CL TEMPER</u>	1331	31.5/16x76.5/8 (NAR. 3'x7')				
<u>HERCULITE DOOR LITE</u>	1561	35.3/4x78.3/8 (2 HOLES)-7FT DOOR				

<u>DESCRIPTION</u>	<u>No.</u>	<u>SIZES</u>					
<u>1/8" CLEAR MIRROR</u>	2021	48x96					
<u>1/8" BRONZE MIRROR</u>	2022	48x84					
<u>1/8" GRAY MIRROR</u>	2023	48x84					
<u>3/16" CLEAR MIRROR</u>	2031	96x130					
<u>1/4" MIRROR PANE</u>	2040	72x130	96x130				
<u>1/4" CLEAR MIRROR</u>	2041	48x100	60x100	72x100	72x120	84x120	96x144
<u>1/4" BRONZE MIRROR</u>	2042	48x100	96x130				
<u>1/4" GRAY MIRROR</u>	2043	48x100	96x130				
<u>1/4" BLACK MIRROR</u>	2046	96x130					
<u>1/4" STARPHIRE MIRROR</u>	2044	96x130					
<u>1/4" CLEAR LAMI</u>	3041	31.3/8x76.5/8 (3'x7' DOOR LITE)			36x84	36x96	42x84
		48x84	48x96	60x96	60x120	72x96	72x120
		84x120	96x130				
<u>1/4" BRONZE LAMI</u>	3042	34x80	48x96	80x120			
<u>1/4" GRAY LAMI</u>	3043	34x80	48x96	80x120			
<u>1/4" WHITE LAMI</u>	3047	48x96	80x120				
<u>3/8" CLEAR LAMI</u>	3051	48x108	60x108	72x108	84x108	84x130	96x130
<u>1/2" CLEAR LAMI</u>	3061	48x108	60x108	72x108	84x108	84x130	96x130
<u>1/2" WHITE LAMI</u>	3067	72x130	96x130				
<u>1/4" PLASTIC</u>	5041	48x96					
<u>3/8" PLASTIC</u>	5051	48x96					
<u>1/2" PLASTIC</u>	5061	48x96					
<u>3/4" PLASTIC</u>	5081	48x96					



















005

FIN TUBING ♦ FASCIA ♦ RECTANGLES

Part No.	Color	Part Drawing	Description	Price
610011	Clear		1/2" x 1/2" Glass Molding - 24 ft	\$
610012	Bronze		(Punched Channel)	\$
610013	Clear		1/2" x 1/2" U-Channel - 24 ft	\$
610014	Bronze		(No Hdes)	\$
60111	Clear		1" x 1" Square Tube - 12 ft	\$
60113	Clear		2 1/2" x 2 1/2" Square Tube - 12 ft	\$
610021	Clear		1" x 1 3/4" Rectangle Tube - 24 ft	\$
610022	Bronze			\$
610031	Clear		1 3/4" x 1 3/4" Square Tube - 24 ft	\$
610032	Bronze			\$
610041	Clear		1 3/4" x 4" No Fin Tube - 24 ft	\$
610042	Bronze			\$
610051	Clear		1 3/4" x 4" Single Fin Tube - 24 ft	\$
610052	Bronze			\$
60171	Clear		1 3/4" x 4" Gasket Fin Tube - 14'-6"	\$
60172	Bronze			\$
610061	Clear		1 3/4" x 4" Double Fin Tube - 24 ft	\$
610062	Bronze			\$
610071	Clear		4" x 4" Square Tube - 24 ft	\$
610072	Bronze			\$
6511	Clear		4 1/2" T - Fascia - 24 ft	\$
6512	Bronze			\$
60125	Clear		1" x 4" Rectangle - 24 ft	\$
60126	Bronze			\$
60127	Clear		1 3/4" x 6" Rectangle - 24 ft	\$
60128	Bronze			\$
6053011	Clear		4 1/2" x 4 1/2" Square Tubing - 24 ft	\$
6053012	Bronze			\$
6053211	Clear		2" x 2" Square Tubing - 24 ft	\$
6053212	Bronze			\$
6053231	Clear		2" x 4 1/2" Rectangle Tubing - 24 ft	\$
6053232	Bronze			\$
6053251	Clear		2" x 6" Rectangle tubing - 24 ft	\$
6053252	Bronze			\$
				\$
				\$

ANGLES ♦ PARTITION ♦ RUBBER ♦ SADDLE







006

Part No.	Color	Part Drawing	Description	Price
6411	Clear		3/4" x 3/4" Angle - 24 ft 1/16" Thick	\$
6412	Bronze			\$
6421	Clear		1" x 1" Angle - 24 ft 1/16" Thick	\$
6422	Bronze			\$
6431	Clear		1 1/2" x 1 1/2" Angle - 24 ft 1/16" Thick	\$
6432	Bronze			\$
6441	Clear		1" x 2" Angle - 24 ft 1/16" Thick	\$
6442	Bronze			\$
6451	Clear		2" x 2" Angle - 24 ft 1/16" Thick	\$
6452	Bronze			\$
6471	Clear		3/4" x 3/4" Angle - 24 ft 1/8" Thick	
6472	Bronze			
6481	Clear		1" x 1" Angle - 24 ft 1/8" Thick	\$
6482	Bronze			\$
6483	Clear		1-1/2" x 1-1/2" Angle - 24 ft 1/8" Thick	\$
6484	Bronze			\$
6491	Clear		2" x 2" Angle - 24 ft 1/8" Thick	\$
6492	Bronze			\$
760411	Clear		Paneling Door (Vertical) - 24 ft	\$
760412	Bronze			\$
760421	Clear		Paneling Door (Horizontal) - 15'-6"	
760422	Bronze			
90R1	Black		Rubber For 1/4" (& 1") Glazing (500ft)	\$
				\$
90R2	Black		Rubber For 1/2" Glazing (500ft)	\$
				\$
90R5	Black		Rubber For Curtain Wall System (700ft)	
6916	Mill		4" Saddle - 15'-2"	\$
				\$
6924	Mill		5" Panic-Shape Saddle - 15'-2"	\$
				\$
6918	Mill		5" Saddle - 15'-2"	\$
				\$
6934	Mill		7" Saddle - 15'-2"	

007

STUCCO ♦ ALUMINUM SHEETS





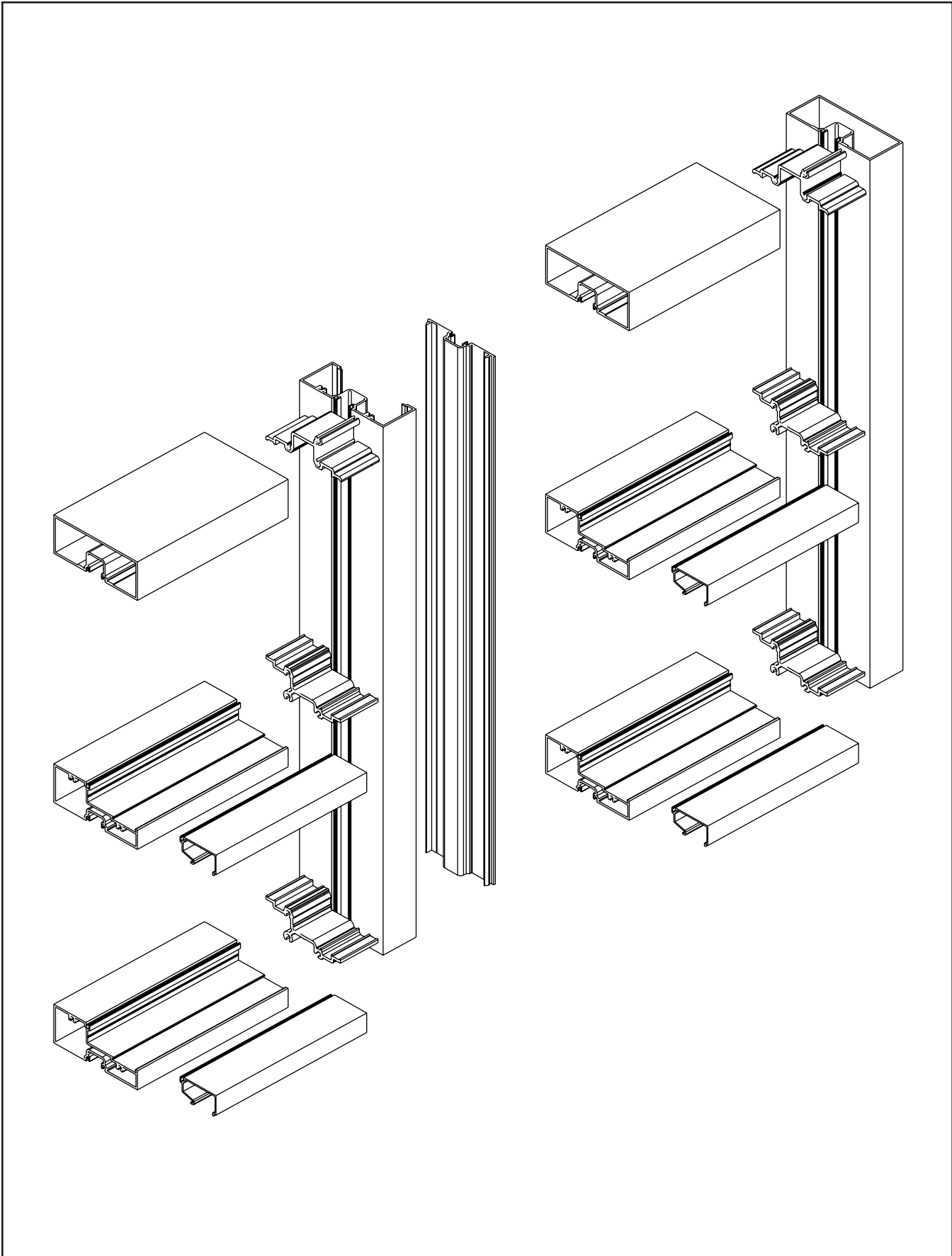









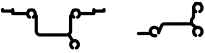

Part No.	Color	Part Drawing	Description	Price	
670031A	Silver Gray	STUCCO PLATE	Stucco, Poly-Metal 4' x 8' x 1/4"	\$	
670032A	Dark Bronze		Stucco, Poly-Metal 4' x 8' x 1/4"	\$	
670041A	Silver Gray		Stucco, Poly-Metal 4' x 10' x 1/4"	\$	
670042A	Dark Bronze		Stucco, Poly-Metal 4' x 10' x 1/4"	\$	
671151I	Silver Gray		Smooth, Poly-Metal 4' x 8' x 1/4"	\$	
671152I	Black		Smooth, Poly-Metal 4' x 8' x 1/4"	\$	
6701151A	Silver Gray		Smooth, Poly-Metal 4' x 10' x 1/4"	\$	
671152IA	Black		Smooth, Poly-Metal 4' x 10' x 1/4"	\$	
670062A	Silver Gray		Stucco, Poly-Metal 4' x 8' x 1"	\$	
670071A	Dark Bronze		Stucco, Poly-Metal 4' x 8' x 1"	\$	
670072A	Silver Gray		Stucco, Poly-Metal 4' x 10' x 1"	\$	
670080	Dark Bronze		Stucco, Poly-Metal 4' x 10' x 1"	\$	
670080I	Silver Gray		Smooth, Poly-Metal 4' x 8' x 1"	\$	
67008I	Dark Bronze		Smooth, Poly-Metal 4' x 8' x 1"	\$	
670082	Silver Gray		Smooth, Poly-Metal 4' x 10' x 1"	\$	
68002I	Dark Bronze	Smooth, Poly-Metal 4' x 10' x 1"	\$		
680022	Clear	ALUMINUM SHEET	Aluminum Sheet 4' x 8' (0.032)	\$	
680024	Black		Aluminum Sheet 4' x 8' (0.032)	\$	
680023	Black/ White		Aluminum Sheet 4' x 8' (0.032)	\$	
68003I	Black/ White		Aluminum Sheet 4' x 10' (0.032)	\$	
680032	Clear		Aluminum Sheet 4' x 10' (0.032)	\$	
680059	Black		Aluminum Sheet 4' x 10' (0.032)	\$	
680062	Clear		Aluminum Sheet 4' x 8' (0.060)	\$	
680060	Black/ White		Aluminum Sheet 4' x 8' (0.060)	\$	
680063	Clear		Aluminum Sheet 4' x 10' (0.060)	\$	
68006I	Black/ White		Aluminum Sheet 4' x 10' (0.060)	\$	
680064	Clear		Aluminum Sheet 4' x 12' (0.060)	\$	
68004I	Black/ White		Aluminum Sheet 4' x 12' (0.060)	\$	
680042	Mill		DIAMOND PLATE	Diamond Plate 4'x8'(1/16")	\$
680043	Mill			Diamond Plate 4'x10'(1/16")	\$
680044	Mill			Diamond Plate 4'x8'(1/8")	\$
	Mill	Diamond Plate 4'x10'(1/8")		\$	
				\$	
			\$		
			\$		
			\$		

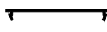









Part No.	Color	Part Drawing	Description	Price
680011	Bk/ Wh		Roll Sheet 24" x 50' (Coil)	\$
680012	Br/ Wh			\$
68111	Brushed	STAINLESS STEEL	20 GA, #4 Satin , 48 x 96	\$
68112	Brushed		20 GA, #4 Satin , 48 x 120	\$
68113	Brushed		20 GA, #4 Satin , 48 x 144	\$
68211	Mirror		20 GA, #8 Polished , 48 x 96	\$
68212	Mirror		20 GA, #8 Polished , 48 x 120	\$
68213	Mirror		20 GA, #8 Polished , 48 x 144	\$
68302	Brushed		BRASS	0.040, #4 Brushed , 48 x 120
68402	Mirror	0.040, #8 Polished , 48 x 120		\$
95U111	Clear		U-Channel for 1" (1/8" Thick) 24ft	\$
95U112	Bronze			\$
95U121	Clear		U-Channel for 1/2" (1/8" Thick) 24ft	\$
95U122	Bronze			\$
95U31A	Clear		U-Channel for 3/4" (1/8" Thick) 24ft	\$
95U31B	Bronze			\$
95U11P	Pd Chrome		U-Channel for 3/8" (1/16" Tk) 12ft	\$
95U11PB	Bright Gold		U-Channel for 3/8" (1/16" Tk) 8ft	\$
95U11PN5	Pol. Nickel		U-Channel for 3/8" (1/16" Tk) 8ft	\$
95U11SN	Brush Nickel		U-Channel for 3/8" (1/16" Tk) 8ft	\$
95U341	Pd Chrome		U-Channel for 1/2" (1/16" Tk) 12ft	\$
95U6411	Bright Gold		U-Channel for 1/2" (1/16" Tk) 8ft	\$
95U340A	Pol Nickel		U-Channel for 1/2" (1/16" Tk) 8ft	\$
95U340B	Brush Nickel		U-Channel for 1/2" (1/16" Tk) 12ft	\$
95U113	Clear		U-Channel for 1/4" (0.090 Thick) 12ft	\$
95U114	Bronze			\$
95U11A	Clear		U-Channel for 3/8" x 5/8" (0.090 Thick) 12ft	\$
95U11B	Bronze			\$
95U11C	Clear		U-Channel for 3/8" x 1" (0.090 Thick) 12ft	\$
95U11D	Bronze			\$
95U12A	Clear		U-Channel for 1/2" x 3/4" (0.090 Thick) 12ft	\$
95U12B	Bronze			\$
95U12C	Clear		U-Channel for 1/2" x 1.25" (0.090 Thick) 12ft	\$
95U12D	Bronze			\$
	Clear			\$
	Bronze			\$

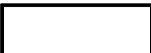

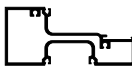
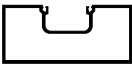
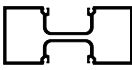
1/4" FLUSH GLAZE POCKET SYSTEM TUBING

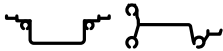
010

Part No.	Color	Part Drawing	Description	Price
620021	Clear		1.3/4" x 4.1/2" Rectangle Tube - 24 ft	\$
620022	Bronze			\$
620031	Clear		1/4" Square Sill Cap - 24 ft	\$
620032	Bronze			\$
620041	Clear		1.3/4" x 4.1/2" Sill Closed Back - 24 ft	\$
620042	Bronze			\$
620051	Clear		1.3/4" x 4.1/2" Single Pocket - 24 ft	\$
620052	Bronze			\$
620061	Clear		1.3/4" x 4.1/2" Double Pocket - 24 ft	\$
620062	Bronze			\$
620071	Clear		1/4" Snap-In Door Stop w/ Felt - 24 ft	\$
620072	Bronze			\$
620081	Mill		1/4" Sill Clip - 6 ft	\$
620082	Mill		1/4" Head Clip - 6 ft	\$
630011	Clear		1/4" Pocket Filler - 24 ft	\$
630012	Bronze			\$
630011A	Clear		1/4" Pocket Filler w/ Felt - 24 ft	\$
630012A	Bronze			\$
630021	Clear		Snap-In Flat Back - 24 ft	\$
630022	Bronze			\$
630031	Clear		1/4" Snap-In Pocket Back - 24 ft	\$
630032	Bronze			\$
630051	Clear		1.3/4" x 4.1/2" Single Pocket Opened Back - 24 ft	\$
630052	Bronze			\$
630061	Clear		4.1/2" x 4.1/2" No Pocket Corner Post - 24 ft	\$
630062	Bronze			\$
630071	Clear		4.1/2" x 4.1/2" Single Pocket Corner Post - 24 ft	\$
630072	Bronze			\$
630081	Clear		4.1/2" x 4.1/2" Double Pocket Corner Post - 24 ft	\$
630082	Bronze			\$
630091	Clear		4.1/2" x 4.1/2" High Base Sill - 24 ft	\$
630092	Bronze			\$
620091	Clear		135 Deg Corner Mullion - 24 ft	\$
620092	Bronze			\$
6053011	Clear		4.1/2" x 4.1/2" Square Tubing - 24 ft	\$
6053012	Bronze			\$

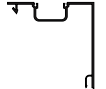
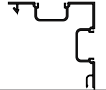
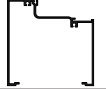
Part No.	Color	Part Drawing	Description	Price
6053211	Clear		2" x 2" Square Tubing - 24 ft	\$
6053212	Bronze			\$
6053231	Clear		2" x 4.1/2" Rectangle Tubing - 24 ft	\$
6053232	Bronze			\$
6053251	Clear		2" x 6" Rectangle tubing - 24 ft	\$
6053252	Bronze			\$
640031	Clear		1" Square Sill Cap - 24 ft	\$
640032	Bronze			\$
640041	Clear		2" x 4.1/2" Sill Closed Back - 24 ft	\$
640042	Bronze			\$
640051	Clear		2" x 4.1/2" Single Pocket - 24 ft	\$
640052	Bronze			\$
640061	Clear		2" x 4.1/2" Double Pocket - 24 ft	\$
640062	Bronze			\$
640071	Clear		1" Snap-In Door Stop w/ Felt - 24 ft	\$
640072	Bronze			\$
640081	Mill		1" Head Clip - 6 ft	\$
640082	Mill			1" Sill Clip - 6 ft
650011	Clear		1" Pocket Filler - 24 ft	\$
650012	Bronze			\$
650031	Clear		1" Snap-In Pocket Back - 24 ft	\$
650032	Bronze			\$
650051	Clear		2" x 4.1/2" Single Pocket Opened Back - 24 ft	\$
650052	Bronze			\$
650071	Clear		4.1/2" x 4.1/2" Single Pocket Corner Post - 24 ft For 1" Glazing	\$
650072	Bronze			\$
650081	Clear		4.1/2" x 4.1/2" Double Pocket Corner Post - 24 ft For 1" Glazing	\$
650082	Bronze			\$
650091	Clear		4.1/2" x 4.1/2" High Base Sill - 24 ft For 1" Glazing	\$
650092	Bronze			\$
				\$
				\$
				\$
				\$
				\$

Sunshine Glass Aluminum Door

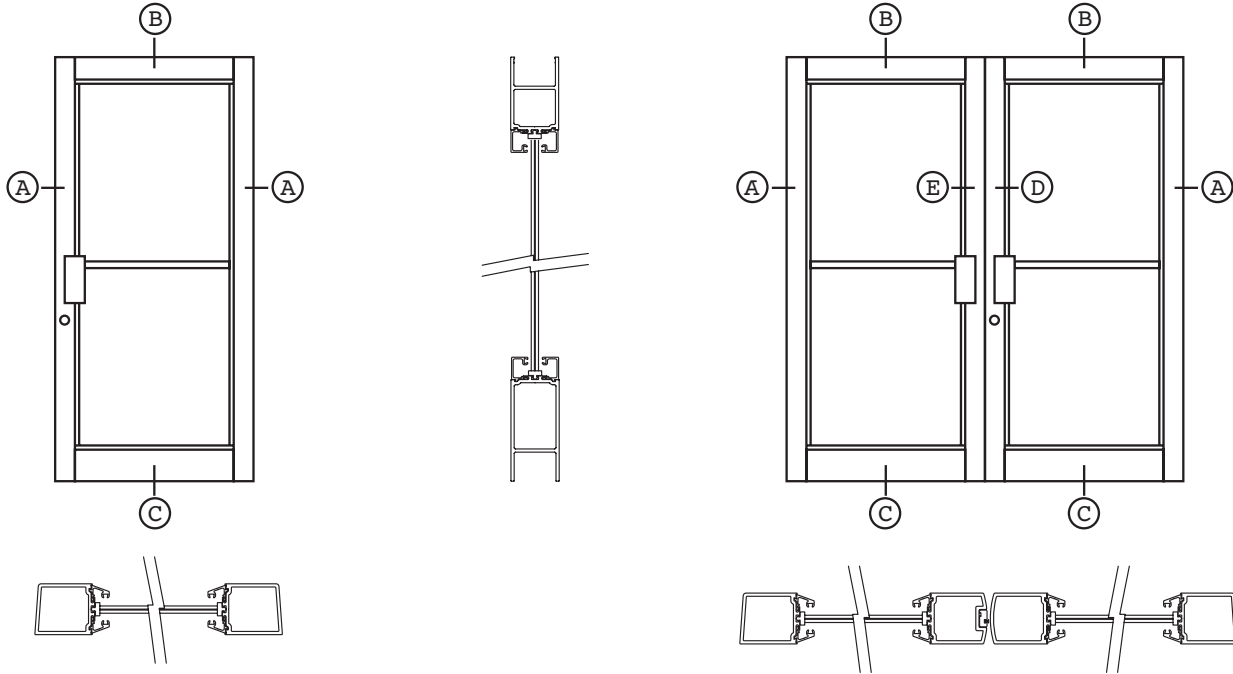



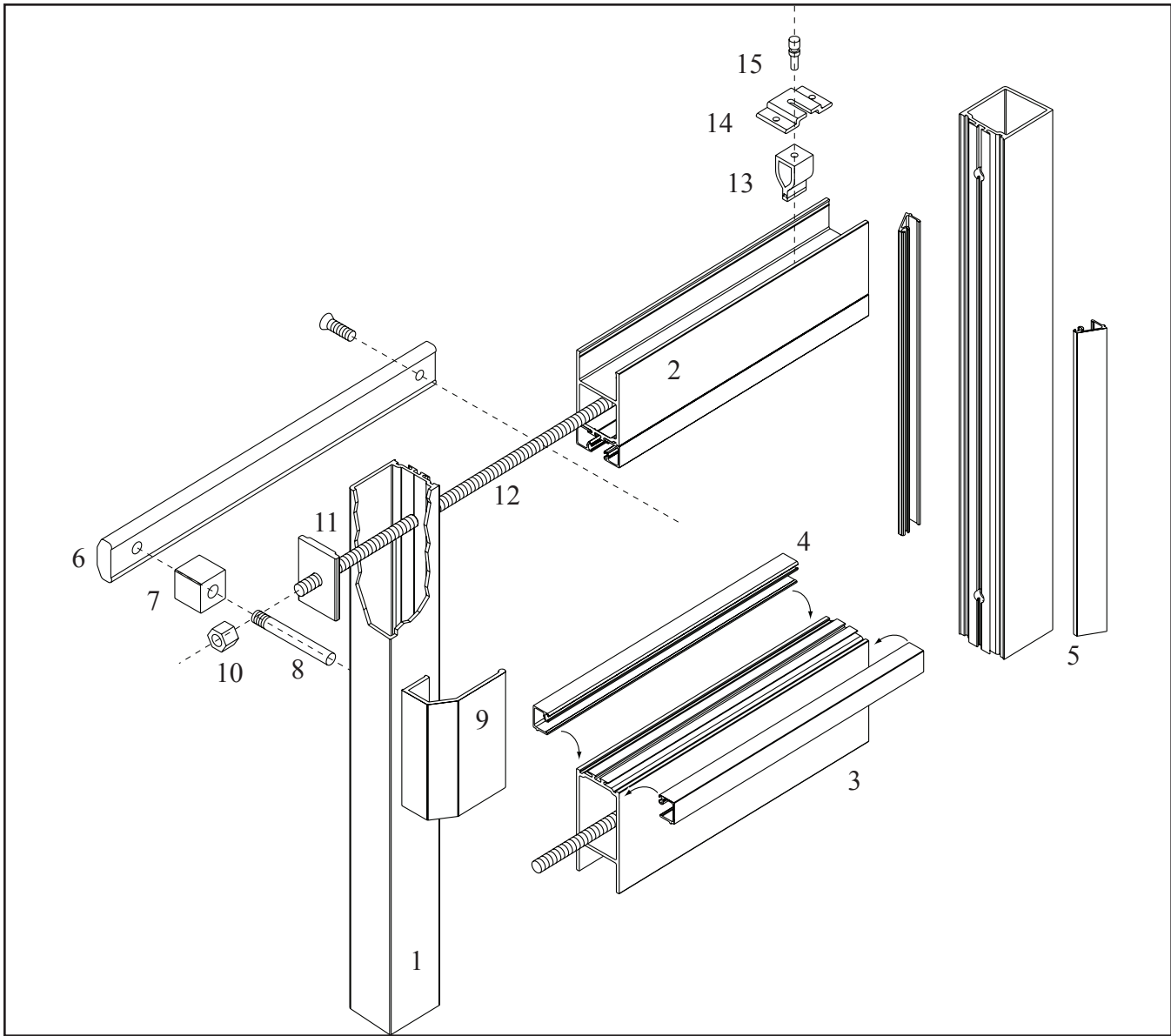





Narrow Stile	Medium Stile	Wide Stile
<p>(A) </p>	<p>(A) </p>	<p>(A) </p>
<p>(B) </p>	<p>(B) </p>	<p>(B) </p>
<p>(C) </p>	<p>(C) </p>	<p>(C) </p>
<p>(D) </p>	<p>(D) </p>	<p>(D) </p>
<p>(E) </p>	<p>(E) </p>	<p>(E) </p>
<p>Molding</p> <p>(F) </p> <p>(G) </p>		



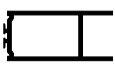



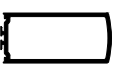
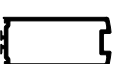

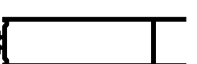
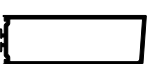
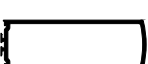
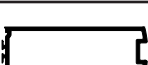
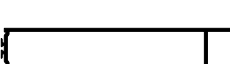





















No.	Desription	No.	Desription
1	Vertical Rail	9	Pull Handle
2	Top Rail	10	Kept Nut
3	Bottom Rail	11	Support Plate
4	Square Molding	12	Threaded Rod
5	Bevel Molding	13	Adjuster
6	Push Bar Handle	14	Adjuster Retainer
7	Push Bar Spacer	15	Adjuster Screw
8	Push Bar Stud		

ALUMINUM DOOR STOCK LENGTH

018

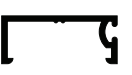
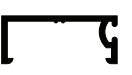
Part No.	Color	Part Drawing	Description	Price
710011	Clear		Narrow Stile Hinge Rail - 14'-2", 8'-2"	\$
710012	Bronze			\$
710021	Clear		2 ¹ / ₂ " Narrow Stile Top Rail - 13'-7"	\$
710022	Bronze			\$
710031	Clear		3 ¹ / ₂ " Narrow Stile Bottom Rail - 13'-7"	\$
710032	Bronze			\$
710041	Clear		Narrow Stile Center Hung Rail - 14'-2", 8'-2"	\$
710042	Bronze			\$
710061	Clear		Narrow Stile Lock Rail - 14'-2", 8'-2"	\$
710062	Bronze			\$
710061A	Clear		Narrow Stile Felt Rail - 15'-2"	\$
710062A	Bronze			\$
720011	Clear		Medium Stile Hinge Rail - 14'-2", 8'-2"	\$
720012	Bronze			\$
720031	Clear		Medium Stile Center Hung Rail - 14'-2", 8'-2"	\$
720032	Bronze			\$
720051	Clear		Medium Stile Lock Rail - 14'-2", 8'-2"	\$
720052	Bronze			\$
720051A	Clear		Medium Stile Felt Rail - 15'-4"	\$
720052A	Bronze			\$
720061	Clear		6 ¹ / ₂ " Medium Stile Bottom Rail - 15'-4"	\$
720062	Bronze			\$
730011	Clear		Wide Stile Hinge Rail - 14'-3", 8'-3"	\$
730012	Bronze			\$
730021	Clear		Wide Stile Center Hung Rail - 14'-3", 8'-3"	\$
730022	Bronze			\$
730031	Clear		Wide Stile Lock Rail - 14'-3", 8'-3"	\$
730032	Bronze			\$
730051	Clear		10" Wide Stile Bottom Rail - 15'-2"	\$
730052	Bronze			\$
				\$
				\$

019**ALUMINUM DOOR STOCK LENGTH**

Part No.	Color	Part Drawing	Description	Price
740011	Clear		3/8" Muntin Bar - 15'	\$
740012	Bronze		3/8" Muntin Bar - 15'	\$
740021	Clear		2" Muntin Bar - 15'	\$
740022	Bronze		2" Muntin Bar - 15'	\$
740031	Clear		4" Muntin Bar - 15'-4"	\$
740032	Bronze		4" Muntin Bar - 15'-4"	\$
740010	Mill		Muntin Adapter - 15'	\$
				\$
750011	Clear		Square Door Molding - 13'-7"	\$
750012	Bronze		Square Door Molding - 13'-7"	\$
750021	Clear		Bevel Door Molding - 13'	\$
750022	Bronze		Bevel Door Molding - 13'	\$
750031	Clear		1" Square Door Molding - 18'-6"	\$
750032	Bronze		1" Square Door Molding - 18'-6"	\$
750041	Clear		Adjustable Astragal w/ felt - 13'	\$
750042	Bronze		Adjustable Astragal w/ felt - 13'	\$
750071	Clear		Sash for 1/4" w/ Cap - 15'-2"	\$
750072	Bronze		Sash for 1/4" w/ Cap - 15'-2"	\$
750073	Clear		Sash for 1/4" w/ Pocket - 15'-2"	\$
750074	Bronze		Sash for 1/4" w/ Pocket - 15'-2"	\$
760011	Clear		Pull Handle - 12'	\$
760012	Bronze		Pull Handle - 12'	\$
760021	Clear		Push Bar - 12'	\$
760022	Bronze		Push Bar - 12'	\$
760031	Clear		Push Bar Spacer - 12'	\$
760032	Bronze		Push Bar Spacer - 12'	\$
630053	Clear		Snap In Door Stop w/ Clip 14'-2"	\$
630054	Bronze		Snap In Door Stop w/ Clip 14'-2"	\$
6200821	Mill		Door Stop Clip - 14"	\$
				\$
750086	Clear		Door Stop for Offset Arm - 24'	\$
750087	Bronze		Door Stop for Offset Arm - 24'	\$

LOCKS & HANDLE

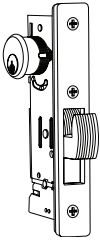

91DB1

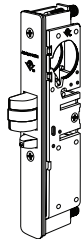

91AS11



91ES

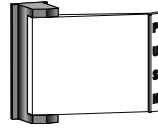

91AS3

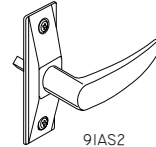

91AS2

Stock No.	Description
91DB1	1.1/8" BS HOOKBOLT
91DB2	1.1/2" BS HOOKBOLT
91ES	LEE ELECTRIC STRIKE
91AS01	DEADBOLT 1.1/8" BS
91AS02	DEADBOLT 1.1/2" BS
91AS11	DEADLATCH 1.1/8" BS
91AS12	DEADLATCH 1.1/2" BS

Stock No.	Description
91AS21	LEVER HANDLE (STRAIGHT) CLEAR
91AS22	LEVER HANDLE (STRAIGHT) BRONZE
91AS23	LEVER HANDLE (EURO) CLEAR
91AS24	LEVER HANDLE (EURO) BRONZE
91AS31	PADDLE HANDLE CLEAR
91AS32	PADDLE HANDLE BRONZE

ADAMS RITE PRODUCTS

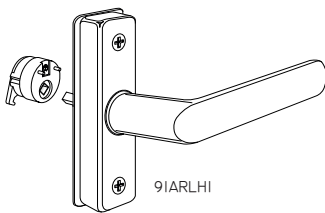

91ARLH1

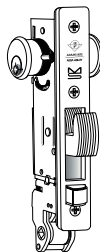

91ARD1

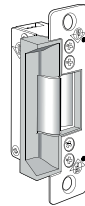

91ARES

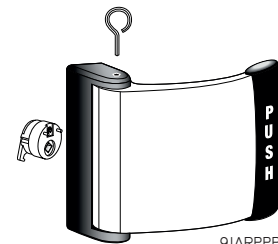

91ARPPP1

Stock No.	Description
91ARD1	AR DEADLOCK/LATCH 1.1/8" BS CL
91ARD2	AR DEADLOCK/LATCH 1.1/8" BS BZ
91ARD3	AR DEADLOCK/LATCH 1.1/2" BS CL
91ARD4	AR DEADLOCK/LATCH 1.1/2" BS BZ
91ARED3630	AR EXIT DEVICE 36" 1.1/2" BS CL
91ARED363A	AR EXIT DEVICE 36" 1.1/8" BS CL
91ARED3640	AR EXIT DEVICE 36" 1.1/2" BS BZ
91ARED364A	AR EXIT DEVICE 36" 1.1/8" BS BZ
91ARED421	AR EXIT DEVICE 42" 1.1/8" BS CL
91ARED422	AR EXIT DEVICE 42" 1.1/8" BS BZ
91ARED423	AR EXIT DEVICE 42" 1.1/2" BS CL
91ARED424	AR EXIT DEVICE 42" 1.1/2" BS BZ

Stock No.	Description
91ARED3610	AR EXIT DEVICE 36" CVR CL
91ARED3620	AR EXIT DEVICE 36" CVR BZ
91ARE1	CYLINDER ESCUTCHEON CL ANO.
91ARE2	CYLINDER ESCUTCHEON BZ ANO.
91ARES1	AR ELECTRIC STRIKE CL 16VAC
91ARES2	AR ELECTRIC STRIKE BZ 16VAC
91ARES3	ELEC STRIKE 12/16/24 VAC/VDC CL
91ARES4	ELEC STRIKE 12/16/24 VAC/VDC BZ
91ARLH1	AR LEVER HANDLE CLEAR
91ARLH2	AR LEVER HANDLE BRONZE
91ARPPP1	AR PUSH/PULL PADDLE CLEAR
91ARPPP2	AR PUSH/PULL PADDLE BRONZE

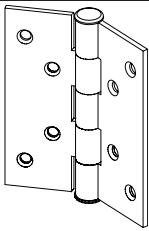

BUTT HINGE

Stock No. Description

91BH1	4"x4.1/2" HINGE CLEAR
91BH2	4"x4.1/2" HINGE BRONZE
91BH3	4"x4.1/2" HINGE POLISH BRASS
91BH4	4"x4.1/2" HINGE SAT. BRASS
91BH5	4"x4.1/2" HINGE SAT. STAINLESS

PIVOT HINGE

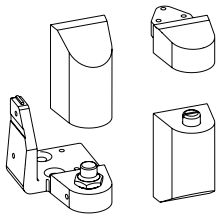

Stock No. Description

91OPLH1	OFFSET PIVOT LH CLEAR
91OPLH2	OFFSET PIVOT LH BRONZE
91OPRH1	OFFSET PIVOT RH CLEAR
91OPRH2	OFFSET PIVOT RH BRONZE



DELUXE HINGE

Stock No. Description

91DH1	DELUXE HINGE CLEAR
91DH2	DELUXE HINGE BRONZE

GEAR (PIANO) HINGE

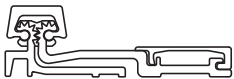

SL-21



SL-11



SL-24

Stock No. Description

9111831	SL11-83" GEAR HINGE CLEAR (7FT)
9111832	SL11-83" GEAR HINGE BRONZE (7FT)
9111951	SL11-95" GEAR HINGE CLEAR (8FT)
9111952	SL11-95" GEAR HINGE BRONZE (8FT)
9121831	SL21-83" GEAR HINGE CLEAR (7FT)
9121832	SL21-83" GEAR HINGE BRONZE (7FT)

Stock No. Description

9121951	SL21-95" GEAR HINGE CLEAR (8FT)
9121952	SL21-95" GEAR HINGE BRONZE (8FT)
9124831	SL14-83" GEAR HINGE CLEAR (7FT)
9124832	SL14-83" GEAR HINGE BRONZE (7FT)
9124951	SL14-95" GEAR HINGE CLEAR (8FT)
9124952	SL14-95" GEAR HINGE BRONZE (8FT)

DORMA SURFACE CLOSER



913031

Stock No. Description

913031	#3 CLOSER CLEAR
913032	#3 CLOSER BRONZE
913041	#4 CLOSER CLEAR
913042	#4 CLOSER BRONZE

Stock No. Description

913051	#5 CLOSER CLEAR
913052	#5 CLOSER BRONZE
913061	#8900 HD CLOSER CLEAR
913062	#8900 HD CLOSER BRONZE

CYLINDERS (ALUMUNUM DOOR)

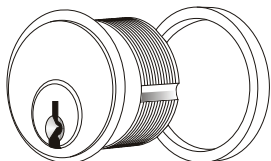

91MK1

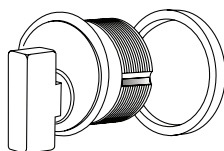

91MT1

Stock No. Description

91MK1	KEY CYLINDER CLEAR
91MK2	KEY CYLINDER BRONZE
91MT1	THUMB TURN CYLINDER CLEAR
91MT2	THUMB TURN CYLINDER BRONZE
91MD1	DUMMY CYLINDER CLEAR
91MD2	DUMMY CYLINDER BRONZE

DOOR STOPS



Stock No.	Description
9IDS1	DROP DOWN DOOR STOP CLEAR
9IDS2	DROP DOWN DOOR STOP BRONZE
9IDSFHI	FLOOR MOUNT DOOR STOP ALUMINUM W/ HOLDER
9IDSWHI	WALL MOUNT DOOR STOP ALUMINUM W/ HOLDER

HANDLES (ALUMINUM DOOR)

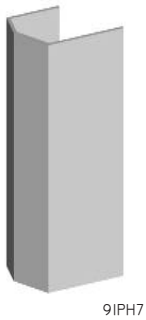

Stock No.	Description	Stock No.	Description
9IPHI	36" PUSHBAR CLEAR	9IPH3	30" PUSHBAR CLEAR
9IPH2	36" PUSHBAR BRONZE	9IPH4	30" PUSHBAR BRONZE
9IPH5	42" PUSHBAR CLEAR	9IPH7	NAR PULL HANDLE CLEAR
9IPH6	42" PUSHBAR BRONZE	9IPH8	NAR PULL HANDLE BRONZE
9IPHM1	MED PULL HANDLE CLEAR		
9IPHM2	MED PULL HANDLE BRONZE		
9IPPHS1	PUSH/PULL HANDLE SET W/SCREW CLEAR		
9IPPHS2	PUSH/PULL HANDLE SET W/SCREW BRONZE		

SLIDING WHEEL & TRACK



Stock No.	Description
7603	SLIDING TRACK
76043SDH	SLIDING WHEEL

FLUSH BOLT



Stock No.	Description
9IFB1	FLUSH BOLT CLEAR
9IFB2	FLUSH BOLT BRONZE

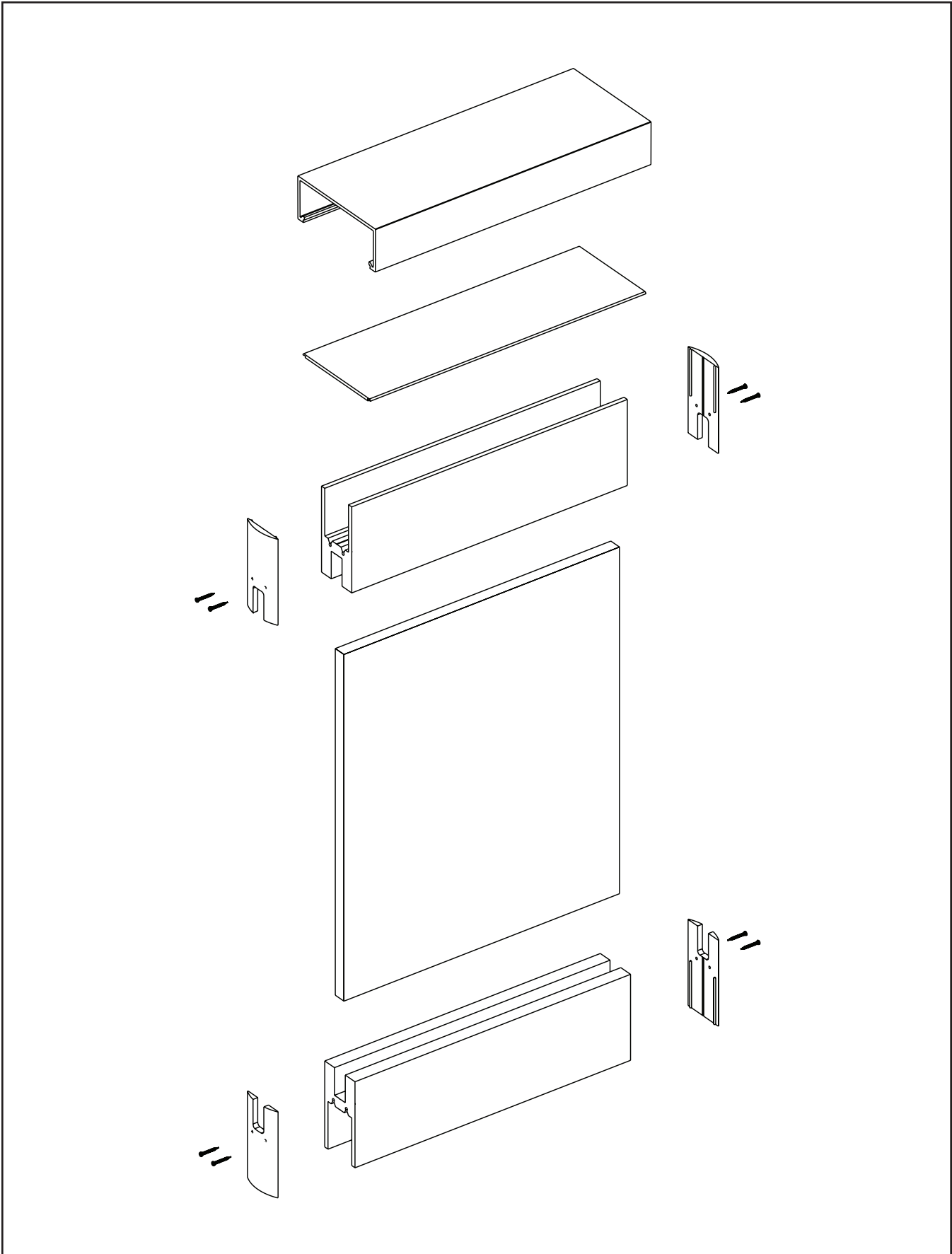

CONCEALED OVER HEAD CLOSERS

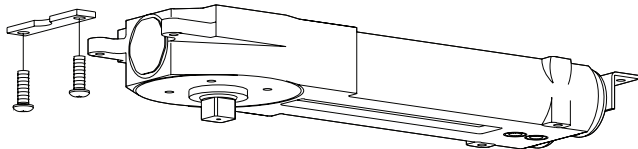

Stock No.	Description
92DC05	DORMA COC 90 DEG HOLD OPEN
92DC07	DORMA COC 105 DEG HOLD OPEN
92DC06	DORMA COC 105 DEG NO HOLD OPEN
92DC08	DORMA COC 90 DEG NO HOLD OPEN
92G03	GLOBAL COC BODY 90 DEG HOLD OPEN
92G04	GLOBAL COC BODY 105 DEG NO HOLD OPEN
92G04A	GLOBAL COC BODY 105 DEG NO HOLD OPEN ADJ
92G05	GLOBAL COC BODY 105 DEG HOLD OPEN
92G05A	GLOBAL COC BODY 105 DEG HOLD OPEN ADJ
92G06	GLOBAL COC BODY 90 DEG NO HOLD OPEN
92J01	JACKSON BOTTOM PIVOT FOR HERCULITE
92J01A	JACKSON BOTTOM PIVOT FOR ALUM DOOR

FLOOR CLOSER

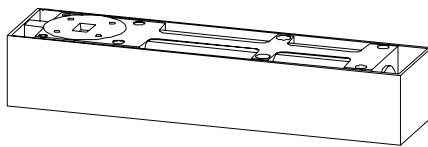

Stock No.	Description
92DF06	BTS-80 DORMA FLOOR CLOSER SZ 4
92DF07	BTS-80 DORMA FLOOR CLOSER SZ 6

CLOSER ARM

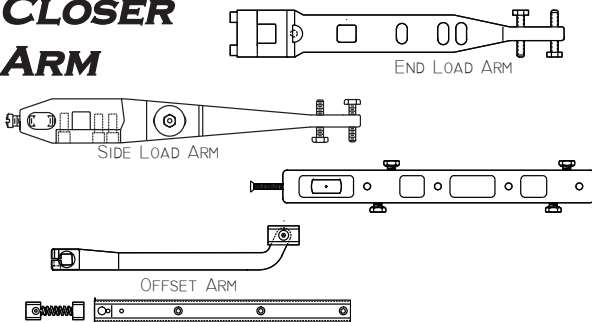

Stock No.	Description
92DC03	DORMA COC TOP LOAD ARM
92DC04	DORMA OFFSET ARM
92DC09	DORMA SIDE LOAD ARM
92DF02	DORMA BOTTOM ARM FOR BTS-80
92J02	JACKSON 1" END LOAD ARM
92J08	JACKSON 5/8" END LOAD ARM
92J11	JACKSON OFFSET ARM
92J10	JACKSON SIDE LOAD ARM

PIVOT

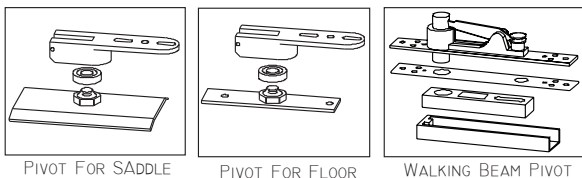

Stock No.	Description
92DC01	DORMA COC PIVOT FOR FLOOR 1.9/16"
92DC01A	DORMA COC PIVOT FOR FLOOR 7/8"
92DC02	DORMA COC PIVOT FOR SADDLE 1.9/16"
92DC02A	DORMA COC PIVOT FOR SADDLE 7/8"
92DF01	DORMA TOP ARM WALKING BEAM PIVOT

FLOOR CLOSER COVER

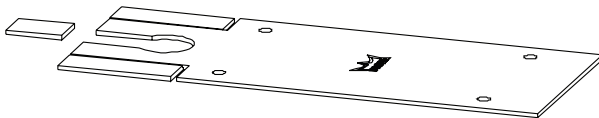

Stock No.	Description
92DF03	COVER PLATE FOR BTS-80 POL STAINLESS
92DF04	COVER PLATE FOR BTS-80 SAT STAINLESS

SPINDLE

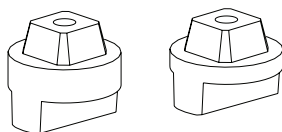

Stock No.	Description	Stock No.	Description
92DF11	1/2" DORMA SPINDLE	92DF14	5/8" DORMA SPINDLE
92DF12	3/4" DORMA SPINDLE	92DF15	7/8" DORMA SPINDLE
92DF13	5/16" DORMA SPINDLE		(SIZE BY CLEARANCE)



ARM ADJUSTING BLOCK

92CAB2	COC ADJUSTER
92CAB1	FLOOR CLOSER ADJUSTER
92CAB3	FLOOR PIVOT ADJUSTER

DUST PROOF STRIKE



Stock No.	Description
92DP3	DUSTPROOF STRIKE POL CHROME
92DP4	DUSTPROOF STRIKE SAT CHROME

ELECTRIC BOLT LOCK



Stock No.	Description
92EBL	SDC ELECTRIC BOLT LOCK
92EBLI	SDC SHEAR EM LOCK
92EBM	SDC SURFACE EM LOCK

END CAPS

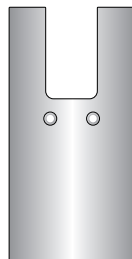

92EC3A

Stock No.	Description
92EC1A	3.1/2" END CAP CLEAR
92EC1AI	4.1/4" END CAP CLEAR
92EC2A	3.1/2" END CAP BRONZE
92EC2AI	4.1/4" END CAP BRONZE
92EC7A	3.5/8" END CAP POL CHROME
92EC3B	4" END CAP POL CHROME
92EC7B	3.5/8" END CAP SAT CHROME
92EC4B	4" END CAP W/ 2 HOLES SAT CHROME
92EC5C	END CAP W/ 1 HOLE POL BRASS
92EC7C	END CAP W/ 2 HOLES POL BRASS
92EC5B	4" END CAP W/ 2 HOLES POL BRASS
92EC6	END CAP W/ 1 HOLE SAT BRASS
92EC7D	END CAP W/ 2 HOLE SAT BRASS
92EC6B	4" END CAP W/ 2 HOLES SAT BRASS

UNIVERSAL PIVOT SET



Stock No.	Description
92GBP	UNIVERSAL BOTTOM PIVOT SET

SOLID BRASS LOCK BODY

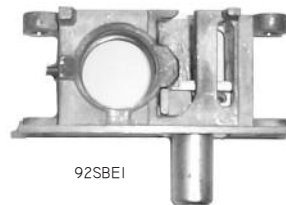

92SBE1

Stock No.	Description
92SBE	LOCK BODY W/ 3/4" BOLT
92SBE1	LOCK BODY W/ 1.3/32" BOLT
92SBE2	LOCK BODY W/ 1.9/16" BODY

CYLINDER (HERCULITE)

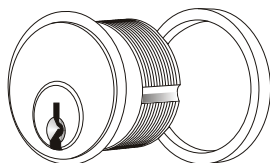

92MK1

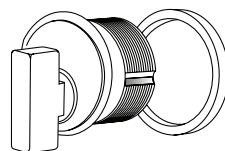

92MT1

Stock No.	Description
92MK1	KEY CYLINDER CLEAR
92MK2	KEY CYLINDER BRONZE
92MK3	KEY CYLINDER POL CHROME
92MK4	KEY CYLINDER SAT CHROME
92MK5	KEY CYLINDER POL BRASS
92MK6	KEY CYLINDER SAT BRASS
92MT1	THUMBTURN CYLINDER CLEAR
92MT2	THUMBTURN CYLINDER BRONZE
92MT3	THUMBTURN CYLINDER POL CHROME
92MT4	THUMBTURN CYLINDER SAT CHROME
92MT5	THUMBTURN CYLINDER POL BRASS

HANDLES

92CPI

920CPI



91PP01A



91PP03A



91PP06F

Stock No.	Description
92CPI	12" C-PULL HANDLE CLEAR
92CP2	12" C-PULL HANDLE BRONZE
92CP5	12" C-PULL HANDLE POL BRASS
92CP6	12" C-PULL HANDLE SAT BRASS
920CPI	12" OFFSET C-PULL HANDLE CLEAR
920CP2	12" OFFSET C-PULL HANDLE BRONZE
920CP5	12" OFFSET C-PULL HANDLE POL BRASS
920CP6	12" OFFSET C-PULL HANDLE SAT BRASS

Stock No.	Description
91PP01A	OFFSET PULL HANDLE 1"x12" CLEAR
91PP01B	OFFSET PULL HANDLE 1"x12" BRONZE
91PP02A	OFFSET PULL HANDLE 1"x10" CLEAR
91PP02B	OFFSET PULL HANDLE 1"x10" BRONZE
91PP06E	10"x33.1/2" PUSH PULL CLEAR
91PP06F	10"x33.1/2" PUSH PULL BRONZE
92PPB1	HANDLE BUTTON SET CLEAR
92PPB2	HANDLE BUTTON SET BRONZE
92PPB3	HANDLE BUTTON SET POL CHROME
92PPB4	HANDLE BUTTON SET SAT CHROME
92PPB5	HANDLE BUTTON SET POL BRASS

HANDLES



86001



85001



85002



85008

Stock No.	Description
850013	C-PULL 12" BACK TO BACK POL STAINLESS
850014	C-PULL 12" BACK TO BACK SAT STAINLESS
850023	OFFSET C-PULL 12" BACK TO BACK POL STAINLESS
850024	OFFSET C-PULL 12" BACK TO BACK SAT STAINLESS

Stock No.	Description
850082	6" BTB SHOWER DOOR HANDLE POL BRASS
850083	6" BTB SHOWER DOOR HANDLE POL CHROME
850084	6" BTB SHOWER DOOR HANDLE SAT CHROME
850085	6" BTB SHOWER DOOR HANDLE BRUSH NICKEL
850086	6" BTB SHOWER DOOR HANDLE POL NICKEL

86001 CUSTOM HANDLE, CUSTOMIZE TO FIT YOUR NEEDS, LENGTH FROM 24" TO 120" (BRUSH OR POLISH STAINLESS)

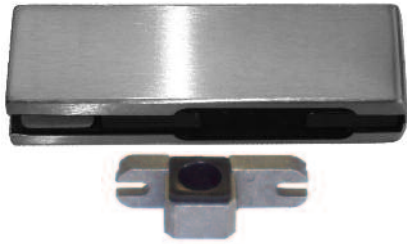

PF 20 (ON DOOR TOP FOR PIVOT)

Stock No.	Description	Stock No.	Description
92PF201	CLEAR ANODIZED	92PF204	POLISH STAINLESS
92PF202	BRONZE ANODIZED	92PF205	SATIN STAINLESS

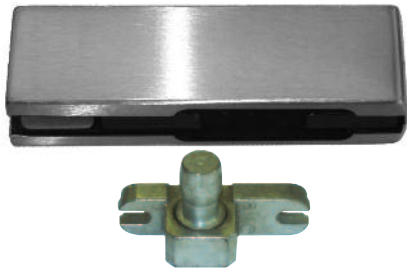

PF 30 (ON FRAME WITH PIVOT)

Stock No.	Description	Stock No.	Description
92PF301	CLEAR ANODIZED	92PF304	POLISH STAINLESS
92PF302	BRONZE ANODIZED	92PF305	SATIN STAINLESS

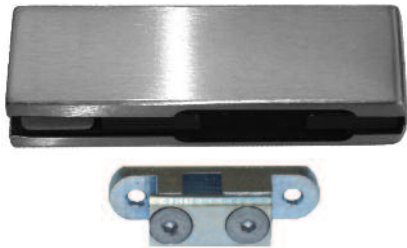

PF 21 (ON DOOR TOP FOR COC)

Stock No.	Description	Stock No.	Description
92PF211	CLEAR ANODIZED	92PF214	POLISH STAINLESS
92PF212	BRONZE ANODIZED	92PF215	SATIN STAINLESS

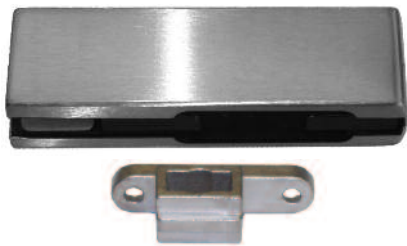

PF 10 (ON DOOR BOTTOM FOR BTS 80)

Stock No.	Description	Stock No.	Description
92PF101	CLEAR ANODIZED	92PF104	POLISH STAINLESS
92PF102	BRONZE ANODIZED	92PF105	SATIN STAINLESS

PATCH LOCKS



Stock No.	Description
92PFL601	PATCH LOCK W/ CYLINDER CLEAR
92PFL602	PATCH LOCK W/ CYLINDER BRONZE
92PFL604	PATCH LOCK W/ CYLINDER POL CHROME
92PFL605	PATCH LOCK W/ CYLINDER SAT CHROME



PF 40

Stock No.	Description	Stock No.	Description
92PF401	CLEAR ANODIZED	92PF404	POLISH STAINLESS
92PF402	BRONZE ANODIZED	92PF405	SATIN STAINLESS



91PH7

Stock No.	Description
92PF601	CLEAR ANODIZED
92PF602	BRONZE ANODIZED

PF 60

Stock No.	Description
92PF604	POLISH STAINLESS
92PF605	SATIN STAINLESS

PATCH HARDWARES



92PFA



92PFB



92PFC



92PFD

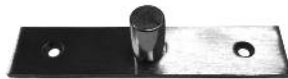

92PFH2



92PFH3



92PFH4

Stock No.	Description
92PFA	BOTTOM SPINDLE FOR BTS-80 (ON PF10)
92PFB	MALE PIVOT INSERT FOR TRANSOM (ON PF30)
92PFC	FEMALE PIVOT INSERT FOR DOOR (PF20)
92PFD	FEMALE COC INSERT FOR DOOR (ON PF21)
92PFH2	PIVOT WITH FIXING PLATE PF20
92PFH3	FIXING PLATE FOR PF30 (CL, BZ, PS, SS, PB, SB)
92PFH4	STOP INSERT (ON PF 40)
92PFE	FLOOR PIVOT BEARING

PATCH DOOR SYSTEMS

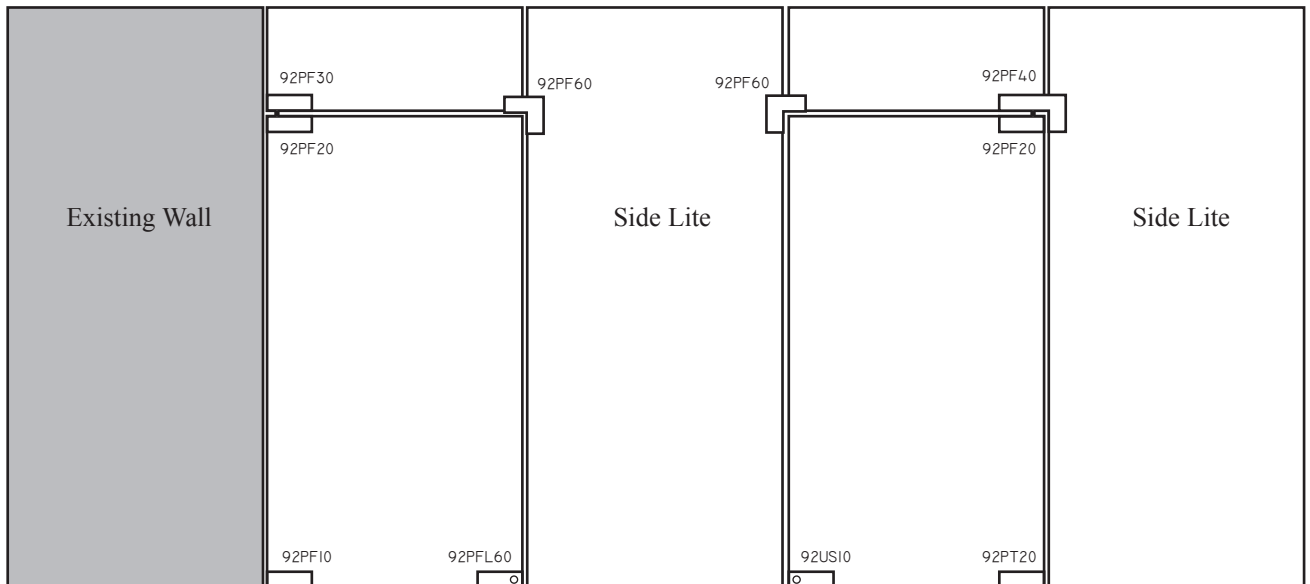



90GU



90PA



90MM

MIRROR GLUE

Stock No.	Description
90PA	PALMER MIRROR-MASTIC
90GU	GUNTHER I GA
90MM	GUNTHER CARTRIDGE



90GCM15



90GPC

GLASS CUTTER

Stock No.	Description
90GCM15	GLASS CUTTER, TOYO PLASTIC HANDLE
90GCM16	GLASS CUTTER, TOYO BRASS HANDLE
90GPC	GLASS POUCH



SILICONE

Stock No.	Description
90SI0	ALUMINUM SILICONE
90SII	CLEAR SILICONE
90SI2	BRONZE SILICONE
90SI3	BLACK SILICONE
90SI4	WHITE SILICONE



CASH TRAY

Stock No.	Description
90CT8	8" CASH TRAY
90CT12	12" CASH TRAY
90CT18	18" CASH TRAY



90SGC

90EPO

SPRAYS

Stock No.	Description
90EPO	POLISHING OIL
90SGC	GLASS CLEANER

PLASTIC GLUE

Stock No.	Description
90PG1	PLASTIC GLUE (2 OZ)
90PG2	PLASTIC GLUE (16 OZ)
90PC	PLASTIC GLUE APPLICATOR

DIAMOND DRILL BIT



Stock No.	Description
90DD14	1/4" DRILL
90DD38	3/8" DRILL
90DD58	5/8" DRILL
90DD12	1/2" DRILL
90DD34	3/4" DRILL
90DD78	7/8" DRILL
90DD01	1" DRILL
90DD118	1.1/8" DRILL
90DD1316	1.3/16" DRILL

Stock No.	Description
90DD114	1.1/4" DRILL
90DD112	1.1/2" DRILL
90SSI34	1.3/4" DRILL
90DD02	2" DRILL
90DD214	2.1/4" DRILL
90DD212	2.1/2" DRILL
90DD03	3" DRILL
90DD312	3.1/2" DRILL
90DD04	4" DRILL

DOUBLE SIDE TAPE



Stock No.	Description
90DTBI	1/2" BLACK (1/16")
90DTB2	3/4" BLACK (1/16")
90DTWI	3/4" WHITE (1/16")
90DTW2	1/2" WHITE (1/32")

BUTYLE TAPE

Stock No.	Description
90DTW3	TREMCO 3/8" BUTYLE TAPE 25 FT (1/8")
90DTW4	TREMCO 1/2" BUTYLE TAPE 25 FT (1/8")
90DTW5	TREMCO POLY SHIM BUTYLE TAPE 50 FT (1/8")

DESCANT MIX



Stock No.	Description
90DM5	DESCANT MIX 5LB

INSULATION CORNER KEYS

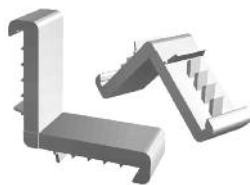

Stock No.	Description
90IK14	1/4" CORNER KEY
90IK38	3/8" CORNER KEY
90IK12	1/2" CORNER KEY
90IK58	5/8" CORNER KEY
90IK34	3/4" CORNER KEY
90IK1116	1 1/16" CORNER KEY

INSULATION SPACER



Stock No.	Description	Stock No.	Description
90IS14	1/4" SPACER	90IS58	5/8" SPACER
90IS38	3/8" SPACER	90IS34	3/4" SPACER
90IS12	1/2" SPACER	90IS1116	1 1/16" SPACER

MIRROR PLATE

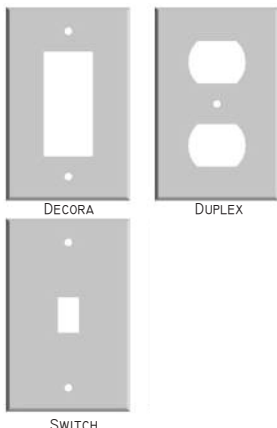

Stock No.	Description
90MPS1	SWITCH SINGLE
90MPS2	DECORA SINGLE
90MPS3	DUPLEX SINGLE
90MPDI	SWITCH DOUBLE

Stock No.	Description
90MPD2	DECORA DOUBLE
90MPD3	DUPLEX DOUBLE
90MPD4	SWITCH / DUPLEX
90MPD5	DECORA / DUPLEX

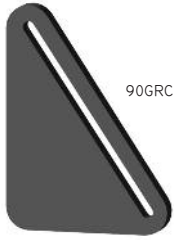

90GRC

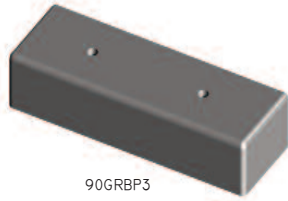

90GRBP3

TRUCK ACCESSORY

Stock No.	Description
90GRBP3	GLASS TRUCK BASE PAD
90GRC	GLASS TRUCK RACK CLEATS

RUBBER SETTING BLOCK

Stock No.	Description	Stock No.	Description
90SBR12	1/2x1/2x2" BLOCKS	90SBR16	1/16x1/4x2" BLOCKS
90SBR14	1/4x1/4x2" BLOCKS	90SBR18	1/8x1/4x2" BLOCKS
90SBR38	1/4x3/8x2" BLOCKS		



SCREWS



Stock No.	Description	Stock No.	Description
90S11	PH FLAT #10-24x1/2" ZINC	90S52	PH RD SELF DR #8-3/4"
90S12	PH FLAT #10-24x1/2" BRONZE	90S53	PH RD SELF DR #8-1.1/4"
90S2	PH ROUND #10-24x1/2" ZINC	90S54	PH RD HEAD SELF DR #10-2"
90S31	PH FLAT #6-1" ZINC	90S7	PH ROUND HEAD #12-1.3/4"
90S32	PH FLAT #6-1" BRONZE	90S8	PH ROUND HEAD #10-2"
90S41	PH FLAT #12-24x1/2" ZINC	90S90	PH FT HEAD #12-2"
90S42	PH FLAT #12-24x1/2" BRONZE	90S91	PH FT HEAD #12-2.1/2"
90S51	PH RD SELF DR #10-5/8"	90S92	PH FT HEAD #12-3.1/2"

SANDING BELT



Stock No.	Description
90SB40	3"x24" 40 GRIT
90SB60	3"x24" 60 GRIT
90SB80	3"x24" 80 GRIT
90SB120	3"x24" 120 GRIT
90SB121	1.1/8"x21" 120 GRIT
90SB122	1.1/8"x21" 80 GRIT
90SB220	3"x24" 220 GRIT
90SB400	3"x24" 400 GRIT

VACUUM CUP



90VC

Stock No.	Description
90VC	8" METAL HANDLE VACUUM CUP

TUBING HARDWARE



93BP



93C80



93C81

Stock No.	Description
93BP	1/8" BACK PLATE
93BPT	3/16" BACK PLATE
93C80	#80 TUBING CLIP
93C81	#81 TUBING CLIP
93CES	CLIP FOR ELECTRIC STRIKE
93SC	SADDLE CLIP

DRILL BITS



93CS18



93DB316

Stock No.	Description
93CS10S	COUNTERSINK (SMALL)
93CS18	COUNTERSINK (LARGE)
93DB18	1/8" DRILL BIT
93DB532	5/32" DRILL BIT
93DB316	3/16" DRILL BIT
93DB14A	1/4" DRILL BIT

SPEAR BITS

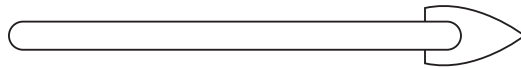

Stock No.	Description
93SD1B	3/16" SPEAR BIT
93SD2B	1/4" SPEAR BIT
93SD3B	5/16" SPEAR BIT

SPRAY PAINT



93SP0



93SP2



93SP1

Stock No.	Description
93SP2	ALUMINUM SPRAY PAINT
93SP3	BLACK / BRONZE SPRAY PAINT

SHOWCASE TRACK SYSTEM

Stock No.	Description
94HB1181	H-BAR SLIDING SHOE 1.1/8" CLEAR
94HB1182	H-BAR SLIDING SHOE 1.1/8" BRONZE
94HB1581	H-BAR SLIDING SHOE 1.5/8" CLEAR
94HB1582	H-BAR SLIDING SHOE 1.5/8" BRONZE
94LDT1	1.3/16" LOWER DOUBLE TRACK CLEAR
94LDT2	1.3/16" LOWER DOUBLE TRACK BRONZE
94UDT1	1.3/16" UPPER DOUBLE TRACK CLEAR
94UDT2	1.3/16" UPPER DOUBLE TRACK BRONZE
94PW	PLASTIC WHEEL
94SWI	STEEL WHEEL W/ BALL BEARING

SHOWCASE TRACK SYSTEM

Stock No.	Description
94DT	1" DOUBLE TRACK CLEAR
94FP	STICK-ON FINGER PULL
94RC	ROLLER CARRIER
94PS	PLASTIC SHOE FOR 1/4"
94SS14	POL CHROME SHOE FOR 1/4"

SHOWCASE LOCK

94SPL

94SDL

Stock No.	Description
94SPL	SLIDING DOOR LOCK TDK-7
94SDL	SHOWCASE PUSH LOCK

MIRROR KNOBS

94MK1

94MK2

94MK4

Stock No.	Description
94MK1	MIRROR KNOB (SQUARE) SMALL
94MK2	MIRROR KNOB (SQUARE) MEDIUM
94MK4	MIRROR KNOB LARGE

SHOWER DOOR HINGES



GLASS TO WALL



GLASS TO GLASS



180 DEG



Stock No.

Description

94SDHIA	SHOWER HINGE GL TO GL SAT. CHROME
94SDHIB	SHOWER HINGE GL TO GL POL. CHROME
94SDHIC	SHOWER HINGE GL TO GL POL. BRASS
94SDHID	SHOWER HINGE GL TO GL BRUSH NICKEL
94SDHIE	SHOWER HINGE GL TO GL POL. NICKEL
94SDH3	SHOWER HINGE GL TO WALL POL. CHROME
94SDH3A	SHOWER HINGE GL TO WALL SAT. CHROME
94SDH3B	SHOWER HINGE GL TO WALL POL. BRASS
94SDH3C	SHOWER HINGE GL TO WALL BRUSH NICKEL
94SDH3D	SHOWER HINGE GL TO WALL POL. NICKEL
94SDCIB	SHOWER GL CLAMP V-NOTCH POL. CHROME
94SDC2B	SHOWER GL CLAMP V-NOTCH BRUSH NICKEL
94SDC3B	SHOWER GL CLAMP V-NOTCH POL. BRASS
94SDC3B	SHOWER GL CLAMP V-NOTCH POL. BRASS
94SDC4A	SHOWER GL CLAMP V-NOTCH POL. NICKEL
94SDC4C	SHOWER GL CLAMP V-NOTCH BRUSH NICKEL
94SDCIA	SHOWER TRANSOM CLAMP POL. CHROME
94SDC2A	SHOWER TRANSOM CLAMP SAT. CHROME
94SDC3A	SHOWER TRANSOM CLAMP POL. BRASS
94SDC4	SHOWER TRANSOM CLAMP POL. NICKEL
94SDC4B	SHOWER TRANSOM CLAMP BRUSH NICKEL
94SDH6	SHOWER GLASS SEAL DOOR STOP (3/8")
94SDH6A	SHOWER GLASS SEAL DOOR STOP (1/2")
94SDH7	SHOWER GLASS SEAL DOOR EDGE (3/8")
94SDH7A	SHOWER GLASS H-SEAL DOOR EDGE (3/8")
94SDH7B	SHOWER GLASS H-SEAL DOOR EDGE (1/2")
94SDH8	SHOWER GLASS BOTTOM WIPE (3/8")
94SDH8B	SHOWER GLASS BOTTOM WIPE (1/2")
94SDH9	SHOWER GLASS BOTTOM WIPE W/ DRIP (3/8")
94SDH9B	SHOWER GLASS BOTTOM WIPE W/ DRIP (1/2")

MIRROR MOLDINGS

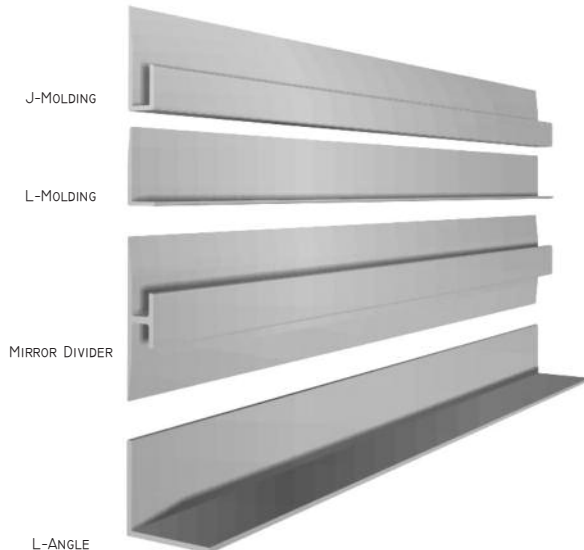

Stock No.

Description

95JM11	3/8" J-MOLDING POL CHROME
95JM13	3/8" J-MILDING BRUSH NICKEL
95JM21	5/8" J-MOLDING POL CHROME
95JM12	3/8" J-MOLDING POL GOLD
95JM22	5/8" J-MOLDING POL GOLD
95JM23	3/8" J-MOLDING SAT. ANO
95JM25	5/8" J-MOLDING BRUSH NICKEL
95LA1	1/2"x1/2" L-ANGLE POL CHROME
95LA2	1"x1" L-ANGLE POL CHROME
95LA3	3/4"x3/4" L-ANGLE POL CHROME
95LM11	5/8"x5/16" L-MOLDING POL CHROME
95LM22	5/8"x5/16" L-MOLDING POL GOLD
95MD1C	MIRROR MOLDING DIVIDER POL CHROME
95MD1D	MIRROR MOLDING DIVIDER SAT. ANO.
95MD2	MIRROR MOLDING DIVIDER BRONZE

GLASS	Clear Glass: 1/16", 1/8", 3/16", 1/4", 3/8", 1/2" Tinted Glass: 1/8", 1/4", 3/8", 1/2" Bronze and Gray Tinted 1/4" Super Gray (Gray Lite 14) Variety of Pattern Glasses
Mirror	Clear Mirror: 1/8", 3/16", 1/4" Tinted Mirror: 1/8", 1/4" Bronze and Gray Tinted Colored Mirror: 1/4" Black Colored
Lami	Clear Lami: 1/4", 3/8", 1/2" Clear Tinted Lami: 1/4" Bronze, Gray and White Lami
Temper	Aluminum Door Lites: 3/16", 1/4" Tempered and Lami Door Lites Herculite Door Lites: (36x84 In-Stock) Custom Size Tempered Glasses
Fabrication	Beveling, Polishing Glass and Mirror
Extrude	Complete line of aluminum tubing for storefronts (Fin, Pocket and Thermo Break, Curtain Wall System), Extrudes for aluminum doors, Aluminum Moldings
Doors	Manufacture Narrow, Medium and Wide Stile Aluminum Doors, Full Line of Herculite(Tempered) Doors. Patch and Full Shoe System.
Stainless Steel	Stainless and Brass Sheets (20 GA) Fabrication : Shearing, Bending and Cladding.
Molding	Glass Moldings, L-Angles, U-Channels, Door Stops, J-Molding(Mirror), L-Molding, Stainless Steel Molding (Customized)
Hardwares	Full line of DORMA C.O.C, Floor Closer; Accessary for Patch Doors; Adams Rite Locks, Strikes and Exit Devices; Jackson COC; Surface Door Closers, ear Hinge (Continuous Hinge), Pivot, Butt Hinge, Silicone, Screws, Locks, Mirror Mastics, Diamond Drills(Hole Saws), Sand Belts, Handles, Tracks, Roller Carrier, Plastic Shoes, Steel Wheels, Plastic Guides, Locks, Shelve Brackets, Shower Door Hinges and Clamps, Etc....

A Sunshine
Glass & Aluminum

**26-10 Brooklyn Queens Expwy West,
Woodside, NY 11377**

Tel 718-932-8080 Fax 718-932-6028